

Data Sheet



Article number: 20927344M520B

Description: E+G Clamping lever GN 927.3-44-M5-20-B
Male thread

Measures

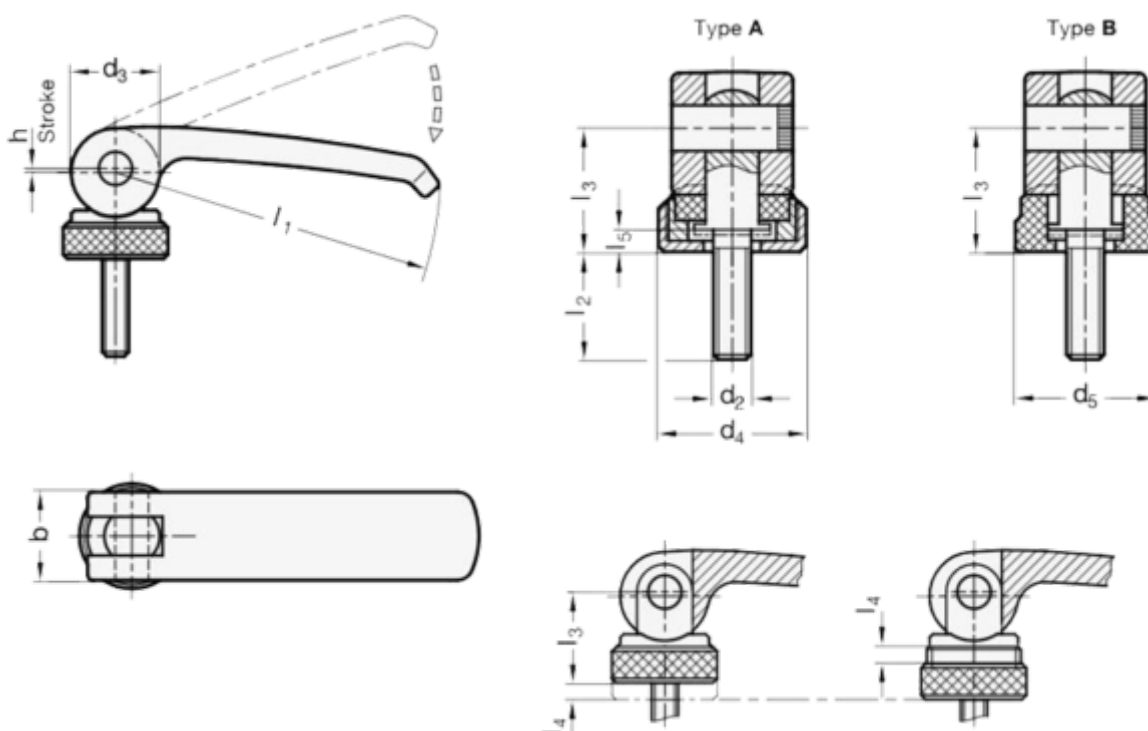

b = 12
d2 = M5
d4 =
d5 = 14
l1 = 44
l2 = 20